

Original Element Data Sheet

Element Type

Description	PT4-2-10Q-B-25
Parker Part No.	936748Q

Dimensional References

A (mm)	103
B (mm)	24 Hex.
D (mm)	78.5
E (mm)	249
H (mm)	64

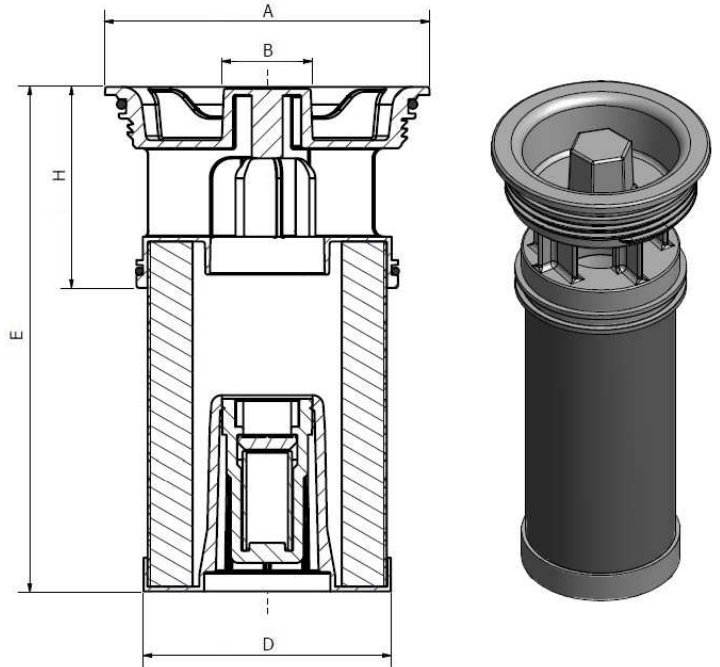

Construction Materials

Seal(s)	NBR (Nitrile)
Top Endcap	Nylon, glass reinforced
Bottom Endcap	Nylon, glass reinforced
Support Cylinder	Mild steel, Tin plated
Filter Media	Multilayer fibreglass with coated mesh support

Performance Criteria

Differential Pressure Clean Element
Acc. to ISO3968 @ 275 L/min, 30cSt \approx 0.55 bar

Efficiency acc. to ISO16889, for $\beta_x(c) \geq 200$
 $x = 10\mu$

Minimum Burst Pressure acc. to ISO2941
10 bar

Dirt Holding Capacity acc. to ISO16889
@ 2 bar terminal pressure drop \approx 46,0 grams